

MERCURY2 SERIES

MER2-160-75GM/C-P

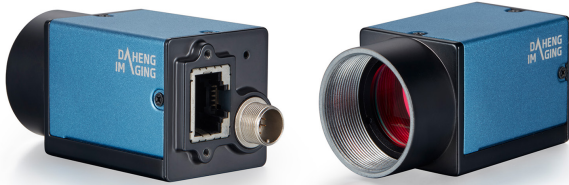

- Minimal exposure time mode
- 1.6 Megapixels
- 1/2.9" global shutter CMOS sensor
- Ultra small, light and robust
- Compatible with GenICam™ and GigE Vision®
- Gigabit Ethernet interface
- Power over Ethernet (PoE)
- 2 programmable GPIOs

The MERCURY2 GigE PoE series (MER2-G-P) camera is DAHENG IMAGING's new generation industrial digital camera. With improved built-in ISP algorithms, MER2-G-P series camera supports more features. Providing multiple acquisition controls, the camera can adapt to various vision applications.

The MER2-160-75GM/C-P camera is a monochrome/color GigE Vision camera with the Sony IMX273 CMOS sensor. Thanks to the compact design (29mm×29mm×40.3mm), robust metal housings and locking screw connectors, the MERCURY2 cameras can secure the reliability of cameras deployed in harsh environments. The MER2-160-75GM/C-P camera has opto-isolated I/Os. The GPIOs give MER2-G-P cameras maximum flexibility to adapt to specific needs.

The MERCURY2 family cameras are especially suitable for machine vision applications such as industrial inspection, medical, scientific research, education, security and so on.

Features

- Power over Ethernet (IEEE802.3af compliant)
- Programmable ROI, increased frame rate with partial scan
- Gain, exposure and white balance programmable (white balance only for color models)
- Support auto gain, auto exposure and auto white balance (auto white balance only for color models)
- Four acquisition controls: Single frame acquisition / Continuous acquisition / Software trigger acquisition / External trigger acquisition
- Trigger mode: Frame Start /Frame Burst Start
- Two exposure time modes: standard exposure time mode / minimal exposure time mode
- Support Decimation, Binning, Digital Shift, Black Level and Reverse X/Y
- Adjustable Gamma and Sharpness for optimizing the brightness and sharpness of images
- Programmable LUTs and storable user sets
- Support Timer and Counter
- Color models support Light source preset, Color Transformation Control and Saturation
- Monochrome models support Noise Reduction
- Adjustable packet-size and packet-delay, and reserved bandwidth
- Support Remove Parameter Limit to expand the range of exposure, gain, white balance, and so on
- 16KB data storage area for saving algorithm coefficients and parameter configuration
- Compatible with GenICam™ and GigE Vision®, can be used in a wide range of 3rd-party software such as HALCON, MERLIC and LabVIEW directly
- Optimized software package for 32/64bit Windows, and support Linux, ARMv7, ARMv8 and Mac OS
- Multiple samples and easy-to-integrate SDKs for various programming tools
- Regulations: CE, RoHS, GenICam, GigE Vision

Performance Specifications

Model	MER2-160-75GM/C-P
Interface	GigE
Resolution	1440(H) × 1080(V)
Frame rate	75.6 fps @ 1440 × 1080
Sensor	1/2.9" Sony IMX273 Global shutter CMOS
Pixel size	3.45 μm × 3.45 μm
Pixel Bit Depth	8bit, 12bit
Spectrum	Monochrome / Color
Exposure time	20μs~1s
Minimal exposure time	1μs~100μs

Optical Specifications

Lens mount	C-Mount (standard), CS-Mount (optional)
------------	---

Electrical Specifications

Power requirement	12~24 VDC via 8-Pin or PoE
I/Os	1 input / 1 output, 2 GPIOs
Data interface	RJ45
Power consumption	<3W@24VDC

Environmental Specifications

Operating temp.	0°C ~ +45°C
Storage temp.	-20°C ~ +70°C
Operating humidity	10% ~ 80%

Mechanical Specifications

Weight	75g
Dimensions	29(W)x29(H)x40.3(L)mm, w/o connectors

Technical Drawing

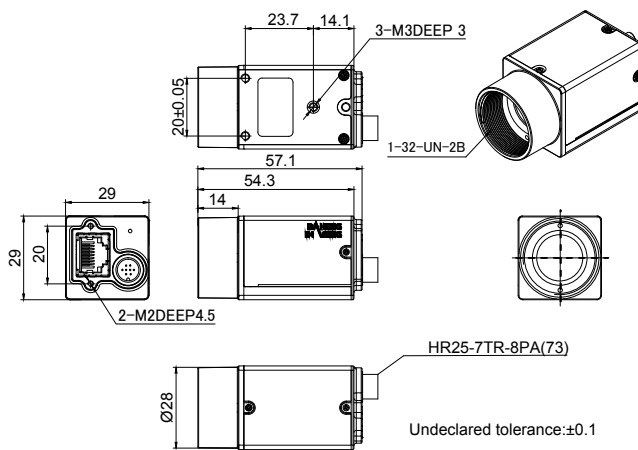

Units: mm

Spectral Response

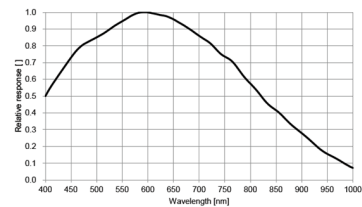

MER2-160-75GM-P

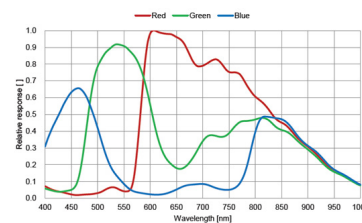

MER2-160-75GC-P

China Daheng Group, Inc. Beijing Image Vision Technology Branch

12F Daheng Science & Technology Tower, No.3 Suzhou Street, Haidian District,

Beijing China, 100080

Tel: +86 10 82828878

E-mail: isales@daheng-imaging.com

For more information please visit : www.daheng-imaging.com/en

Specifications are subject to change without prior notice.

Copyright © 2022 China Daheng Group, Inc. Beijing Image Vision Technology Branch. All rights reserved.

May 19, 2022