

MERCURY2 SERIES

MER2-041-436U3M/C



- 0.4 Megapixels
- 1/2.9" global shutter CMOS sensor
- Ultra small, light and robust
- Compatible with GenICam™ and USB3 Vision®
- USB3.0 interface
- 2 programmable GPIOs

The MERCURY2 USB3.0 series (MER2-U3) camera is DAHENG IMAGING's new generation area scan industrial digital camera, featuring outstanding performance, compact design and extremely low noise.

The MER2-041-436U3M/C camera is a monochrome/color USB3 Vision camera with the Sony IMX287 CMOS sensor. Thanks to the compact design (29mm × 29mm × 29mm), robust metal housings and locking screw connectors, the MERCURY2 cameras can secure the reliability of cameras deployed in harsh environments. The MER2-041-436U3M/C camera has opto-isolated I/Os. The GPIOs give MER2-U3 cameras maximum flexibility to adapt to specific needs.

The MERCURY2 family cameras are especially suitable for machine vision applications such as industrial inspection, medical, scientific research, education, security and so on.

Features

- USB3.0 interface with 10-bit or 8-bit Mono/Bayer output
- Programmable ROI, increased frame rate with partial scan
- Gain, exposure and white balance programmable (white balance only for color models)
- Support auto gain, auto exposure and auto white balance (auto white balance only for color models)
- Three acquisition controls: Continuous acquisition/ Software trigger acquisition/ External trigger acquisition
- Flash sync for firing external lights at precisely the moment when exposure is performed
- Storable user sets
- Support Digital Shift
- Support Reverse X/Y (horizontal and vertical mirroring only for mono models)
- Adjustable URB
- Software reset function
- Robust full metal housing and optional lockable devices
- Compatible with GenICam™ and USB3 Vision®, support a variety of 3rd-party software such as HALCON, MERLIC and LabVIEW
- Optimized software package for 32/64bit Windows, and support Linux, Android, ARMv7 and ARMv8
- Multiple samples and easy-to-integrate SDKs for various programming tools
- Regulations: CE, RoHS, GenICam, USB3 Vision

Performance Specifications

Model	MER2-041-436U3M/C
Interface	USB3.0
Resolution	720(H) × 540(V)
Frame rate	438 fps @720 × 540
Sensor	1/2.9", Sony IMX287 Global shutter CMOS
Pixel size	6.9 μm × 6.9 μm
Pixel Bit Depth	8bit, 10bit
Spectrum	Monochrome / Color
Exposure time	20μs~1s

Optical Specifications

Lens mount	C-Mount (standard), CS-Mount (optional)
------------	---

Electrical Specifications

Power requirement	5 VDC via USB cable
I/Os	1 input / 1 output , 2 GPIOs
Data interface	Micro B with locked
Power consumption	<2.7W @5VDC

Environmental Specifications

Operating temp.	0°C ~ +45°C
Storage temp.	-20°C ~ +70°C
Operating humidity	10% ~ 80%

Mechanical Specifications

Weight	65g
Dimensions	29(W)×29(H)×29(L)mm, w/o connectors

Technical Drawing

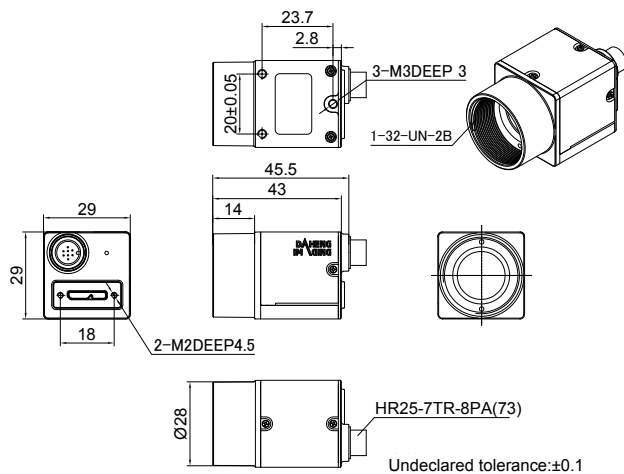

Units: mm

Spectral Response

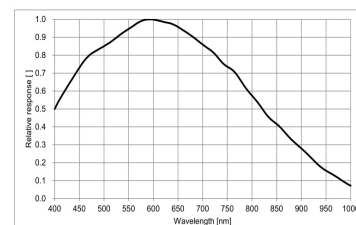

MER2-041-436U3M

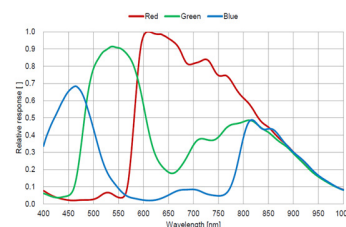

MER2-041-436U3C

China Daheng Group, Inc. Beijing Image Vision Technology Branch

12F Daheng Science & Technology Tower, No.3 Suzhou Street, Haidian District,

Beijing China, 100080

Tel: +86 10 82828878

E-mail: isales@daheng-imaging.com

For more information please visit: www.daheng-imaging.com/en

Specifications are subject to change without prior notice.

Copyright © 2021 China Daheng Group, Inc. Beijing Image Vision Technology Branch. All rights reserved.

August 31, 2021